

# **CYCLONE RESISTANT BUILDING ARCHITECTURE**

**Prepared by:-**

**Ankush Agarwal**

**Technical Officer (Hazard Vulnerability Reduction)**

**GoI – UNDP, Disaster Risk management Programme**

**March, 2007**

## CONTENTS

- 1) Vulnerable Communities**
  - 2) How High Winds Damage Buildings**
  - 3) Catastrophic Failures**
    - 1.1 Foundations
    - 1.2 Steel Frames
    - 1.3 Masonry Houses
    - 1.4 Timber Houses
    - 1.5 Reinforced Concrete Frames
  - 4) Components failure**
    - 4.1 Roof Sheeting
    - 4.2 Roof Tiles
    - 4.3 Rafters
    - 4.4 Windows & Doors
    - 4.5 Walls
  - 5) Damaging Effects of Cyclones**
  - 6) Design Wind Speed & Pressures**
  - 7) When Choosing a Site for your House.**
  - 8) Design of the House.**
  - 9) Roofs**
    - 9.1 Overhangs, patios & verandahs
    - 9.2 Securing the ridge
    - 9.3 Securing the corrugated galvanized sheets
    - 9.4 Laths spacing and fixing
    - 9.5 Hipped roof
    - 9.6 Roof cladding
  - 10) Foundations**
  - 11) Masonry Walls**
    - 11.1 External walls
    - 11.2 Strengthening of walls against wind/cyclones
  - 12) Wall Openings**
  - 13) Glass Panes**
  - 14) References**
- Annexure – A: - Design Procedure for Wind Resistant Buildings**

## 1. Vulnerable Communities

The vulnerability of a human settlement to a cyclone is determined by its siting, the probability that a cyclone will occur, and the degree to which its structures can be damaged by it. Buildings are considered vulnerable if they cannot withstand the forces of high winds. Generally those most vulnerable to cyclones are light-weight structures with wood frames, especially older buildings where wood has deteriorated and weakened the walls. Houses made of unreinforced or poorly-constructed concrete block are also vulnerable.

Urban and rural communities on low islands or in unprotected, low-lying coastal areas or river floodplains are considered vulnerable to cyclones. Furthermore, the degree of exposure of land and buildings will affect the velocity of the cyclone wind at ground level, with open country, seashore areas and rolling plains being the most vulnerable. Certain settlement patterns may create a "funnel effect" that increases the wind speed between buildings, leading to even greater damage.

## 2. How High Winds Damage Buildings

Contrary to popular belief, few houses are blown over. Instead, they are pulled apart by winds moving swiftly around and over the building. This lowers the pressure on the outside and creates suction on the walls and roof, effectively causing the equivalent of an explosion.

Whether or not a building will be able to resist the effects of wind is dependent not so much upon the materials that are used but the manner in which they are used. It is a common belief that heavier buildings, such as those made of concrete block, are safer. While it is true that a well-built and properly-engineered masonry house offers a better margin of safety than other types of buildings, safe housing can be and has been provided by a variety of other materials including wood and many others.

## 3. Catastrophic Failures

### 3.1 Foundations

The uplift forces from cyclone winds can sometimes pull buildings completely out of the ground. In contrast to designing for gravity loads, the lighter the building the larger (or heavier) the foundation needs to be in cyclone resistant design. Ignoring this precept has led to some dramatic failure of long-span, steel-framed warehouses.

### 3.2 Steel Frames

A common misconception is that the loss of cladding relieves the loads from building frameworks. There are several circumstances where the opposite is the case and where the wind loads on the structural frame increases substantially with the loss of cladding.



**Foundation (too small for light weight building) pulled completely out of ground**

Usually the weakness in steel frames is in the connections. Thus economising on minor items (bolts) has led to the overall failure of the major items (columns, beams and rafters).

### **3.3 Masonry Houses**

These are usually regarded as being safe in cyclones. There are countless examples where the loss of roofs has triggered the total destruction of un-reinforced masonry walls.

### **3.4 Timber Houses**

The key to safe construction of timber houses is the connection details. The inherent vulnerability of light-weight timber houses coupled with poor connections is a dangerous combination which has often led to disaster.

### **3.5 Reinforced Concrete Frames**

The design of reinforced concrete frames is usually controlled by the seismic hazard. In countries where this is not an issue care still needs to be exercised to ensure that the concrete frames can accommodate the wind forces. There have been a few isolated examples where, ignoring this, has led to disaster.

## **4. Component Failures**

### **4.1 Roof Sheeting**

This is perhaps the commonest area of failure in cyclones. The causes are usually inadequate fastening devices, inadequate sheet thickness and insufficient frequencies of fasteners in the known areas of greater wind suction.

### **4.2 Roof Tiles**

These were thought to have low vulnerability in storms but past cyclones have exposed the problem of unsatisfactory installation practices.

### **4.3 Rafters**

Of particular interest in recent cyclones was the longitudinal splitting of rafters with the top halves disappearing and leaving the bottom halves in place. The splitting would propagate from holes drilled horizontally through the rafters to receive holding-down straps.



**Total loss of unreinforced concrete block walls and destruction of reinforced concrete supports**



**Destruction of expensive timber framed residence (Bahamas)**



**Loss of corrugated, metal, roof sheets**



**Longitudinal splitting of timber rafters**

#### 4.4 Windows and Doors

After roof sheeting, these are the components most frequently damaged in cyclones. Of course, glass would always be vulnerable to flying objects. The other area of vulnerability for windows and doors is the hardware - latches, bolts and hinges.

#### 4.5 Walls

It is not uncommon for un-reinforced masonry to fail in severe cyclones. Cantilevered parapets are most at risk. But so are walls braced by ring beams and columns have remained safe.

### 5. Damaging Effects of Cyclone on Houses

5.1 Due to the high wind pressure and improper connection of the house to the footings it can be blown away.

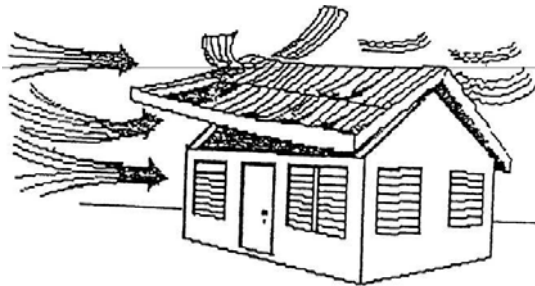
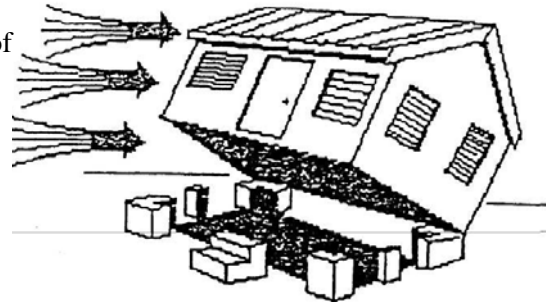

5.2 Roofing materials not anchored can be blown away.

5.3 Light weight verandah roofs are more susceptible to damage due to high wind speed.

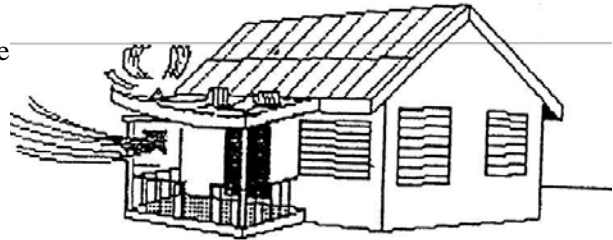

5.4 When cyclones are accompanied with heavy rain for a long duration, the buildings can be damaged due to flooding also. Building contents are spoiled due to rain when roofing sheets fly away.

### 6. Design Wind Speed and Pressures

The basic wind speed is reduced or enhanced for design of buildings and structures due to following factors:

- (i) The risk level of the structure measured in terms of adopted return period and life of structures.
- (ii) Terrain roughness determined by the surrounding buildings or trees and, height and size of the structure.
- (iii) Local topography like hills, valleys, cliffs, or ridges, etc.

Thus general basic wind speed being same in a given zone, structures in different site conditions could have appreciable modification and must be considered in determining design wind velocity as per IS:875 (Part 3) – 1987.

The value of wind pressure actually to be considered on various elements depends on

- (i) Aerodynamics of flow around buildings.
- (ii) The windward vertical faces being subjected to pressure.
- (iii) The leeward and lateral faces getting suction effects and
- (iv) The sloping roofs getting pressures or suction effects depending on the slope. The projecting window shades, roof projections at eave levels are subjected to uplift pressures. These factors play an important role in determining the vulnerability of given building types in given wind speed zones.

Given below are some typical effects of openings in the walls from the attack of winds as well as the pressure on each of the building components:-

- Wind generating opening on the windward side during a cyclone will increase the pressure on the internal surfaces. This pressure, in combination with the external suction, may be sufficient to cause the roof to blow off and the walls to explode.

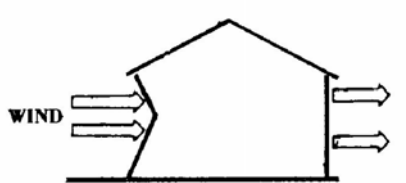
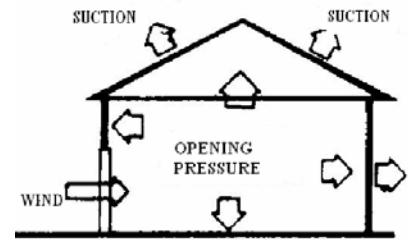

Windward face of the building collapses under pressure of wind force

- Another mode of failure occurs when the windward side of the house collapses under the pressure of the wind.

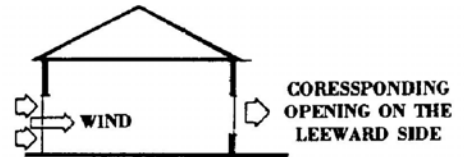

- During a cyclone an opening may suddenly occur on the windward side of the house. The internal pressure which builds up as a result may be relieved by providing a corresponding opening on the leeward side.

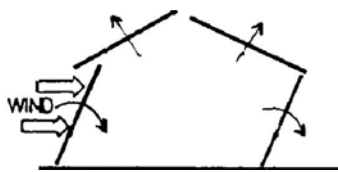

Collapse start at the roof building leaning in the wind direction

- If the building is not securely tied to its foundations, and the walls cannot resist push/pull forces the house tends to collapse starting the roof with the building leaning in the direction of the wind.

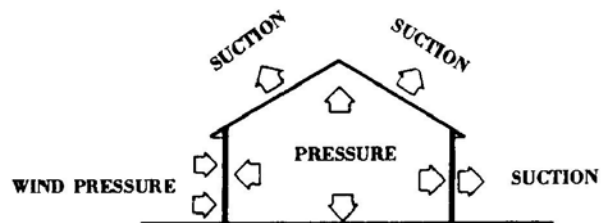

- *Failure of the Wall:* Wind forces on the walls of the house may produce failure. Wind striking a building produces pressure which pushes against the building, on the windward side, and suction which pulls the building on the leeward side and the roof. If no air enters the building, then there is pressure inside which is pushing against the walls and the roof.

- Overturning is another problem for light structures. This occurs when the weight of the house is insufficient to resist the tendency the house to be blown over.

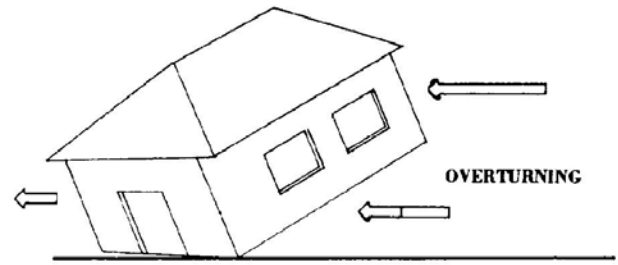

**7. When choosing a site for your house, consider the following:**

The location of the building is important. We often have little choice in the matter, perhaps because of financial constraints. It is as well, therefore, to recognize when a building is being located in a more vulnerable area. The rational response would be to build a stronger-than-normal house.

- (i) Though cyclonic storms always approach from the direction of the sea towards the coast, the wind velocity and direction relative to a building remain random due to the rotating motion of the high velocity winds. In non-cyclonic region where the predominant strong wind direction is well established, the area behind a mound or a hillock should be preferred to provide for natural shielding.



**Shielding of house by hillock**

Similarly a row of trees planted upwind will act as a shield. The influence of such a shield will be over a limited distance, only for 8 – 10 times the height of the trees. A tree broken close to the house may damage the house also hence distance of tree from the house may be kept 1.5 times the height of the tree.

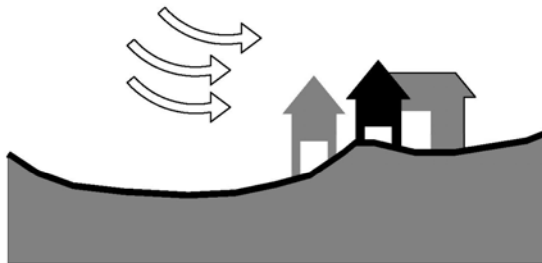

**No shielding from high wind due to absence of barriers**

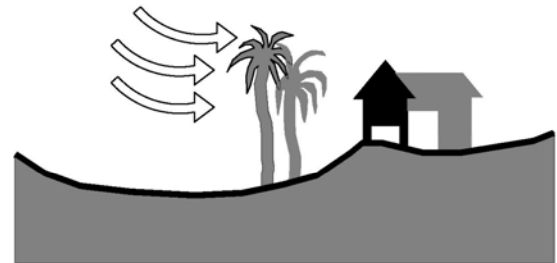

**Shielding from high wind by permeable barriers such as strong trees**

- (ii) In hilly regions, construction along ridges should be avoided since they experience an accentuation of wind velocity whereas valley experiences lower speeds in general. Though some times in long narrow valleys wind may gain high speed along valley
- (iii) In cyclonic regions close to the coast, a site above the likely inundation level should be chosen. In case

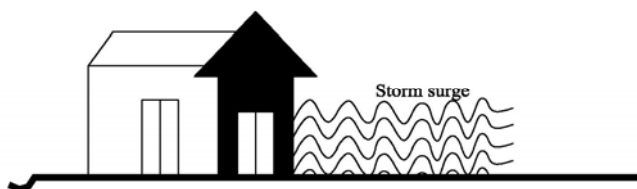

**Construction at ground level risk of inundation**

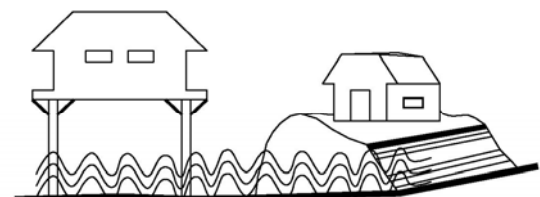

**Construction on stilts or artificially raised earth mounds**

of non availability of high level natural ground, construction should be done on stilts with no masonry or cross bracings up to maximum surge level, or on raised earthen mounds to avoid flooding/inundation but knee bracing may be used.

## 8. Design of the House

We do have control over the shape of new buildings and shape is the most important single factor in determining the performance of buildings in cyclones. Simple, compact, symmetrical shapes are best. The square plan is better than the rectangle since it allows high winds to go around them. The rectangle is better than the L-shaped plan. This is not to say that all buildings must be square. But it is to say that one must be aware of the implications of design decisions and take appropriate action to counter negative features. The best shape to resist high winds is a square.

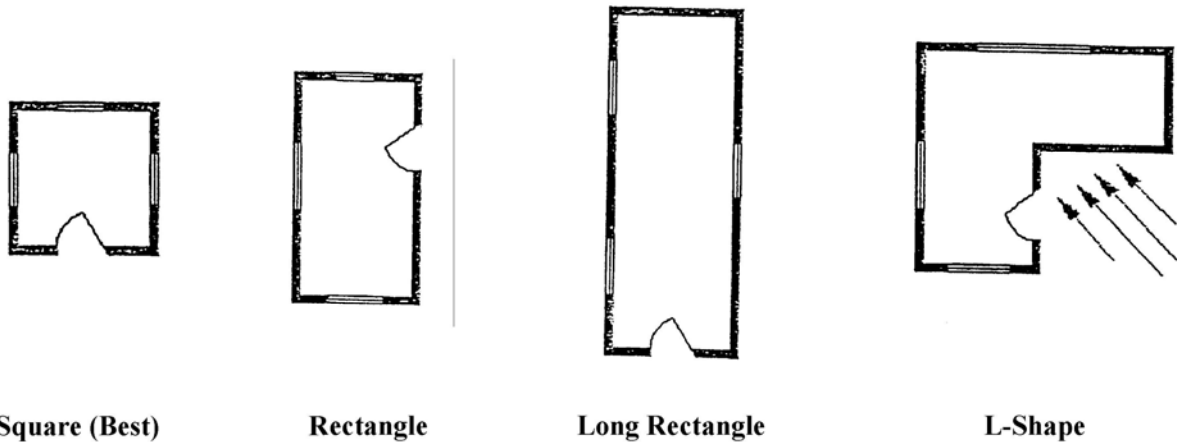

If other shapes are desired, efforts should be made to strengthen the corners.

If longer shapes are used, they must be designed to withstand the forces of the wind. Most houses are rectangular and the best layout is when the length is not more than three (3) times the width.

In case of construction of group of buildings, a cluster arrangement can be followed in preference to row type.

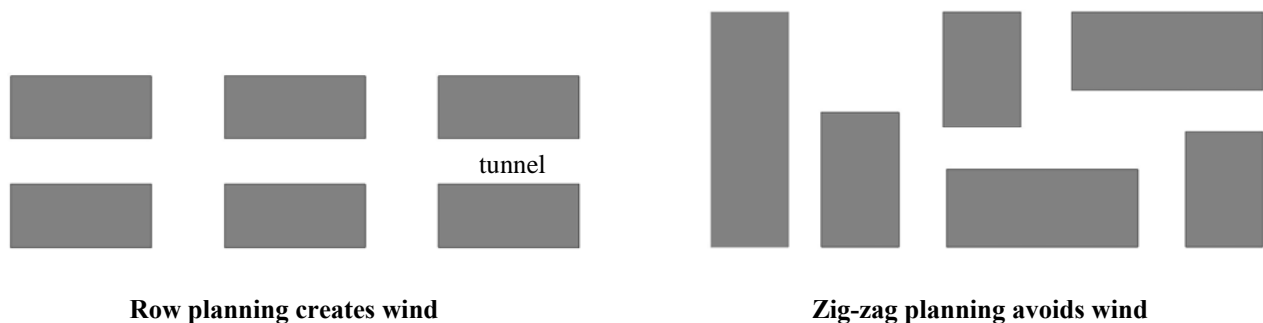



## 9. Roofs

Lightweight flat roofs are easily blown off in high winds. In order to lessen the effect of the uplifting forces on the roof, the roof Pitch should not be less than  $22^{\circ}$ . Hip roofs are best, they have been found to be more cyclone resistant than gable roofs.



Hip Roof



High Gable roof

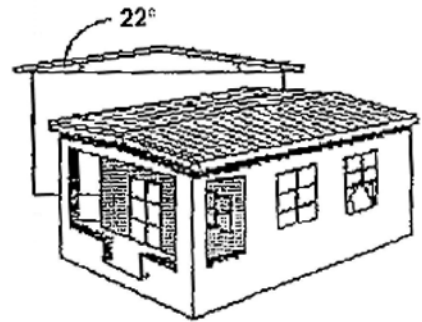

Flat Roof

### General Design Considerations

2. Avoid a low pitched roof, use a hip roof or a high pitched gable roof.
3. Avoid overhanging roofs. If overhangs or canopies are desired, they should be braced by ties held to the main structures.
4. Avoid openings which cannot be securely closed during a cyclone. Where openings are already in existence, cyclone shutters should be provided.

### 9.1 Overhangs, patios and verandahs experience high wind pressures and should be kept short and small

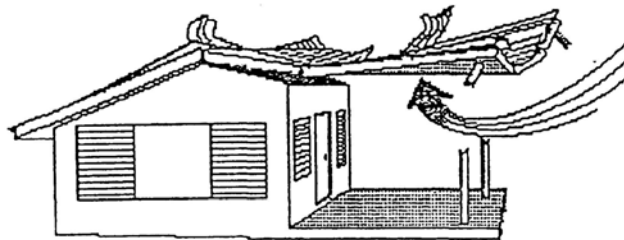
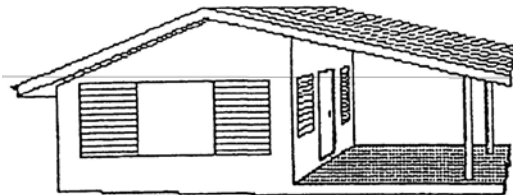

- Avoid large overhangs as high wind force build up under them.
- Overhangs should not be more than 18 inches at verges or eaves.
- Build verandah and patio roofs as separate structures rather than extensions of the main building.
- They may blow off without damaging the rest of the house.

## 9.2 Securing the Ridge

- If the rafters are not secure, the ridge can fall apart when strong wind passes over the roof.

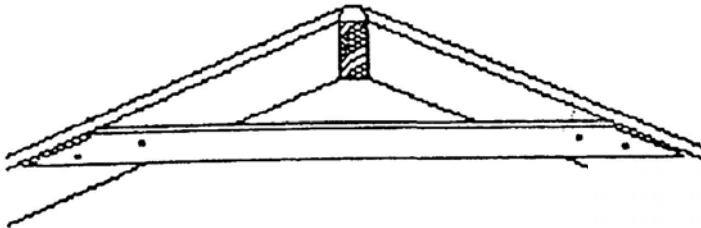
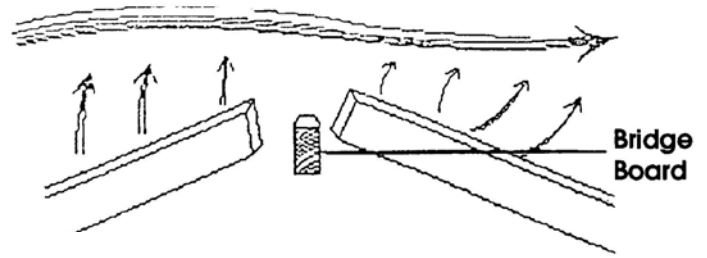

- The ridge can be secured by using:-
  - (i) COLLAR TIES - Timbers connecting the rafters. Nail them to the side of the rafters.

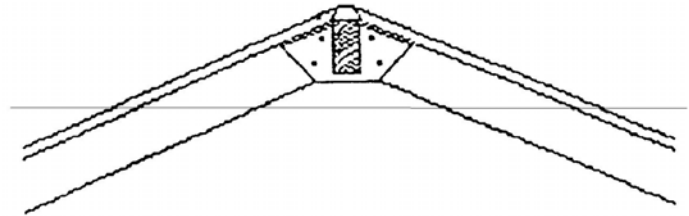

- (ii) GUSSETS - Usually made of steel/plywood. This is used at the ridge.

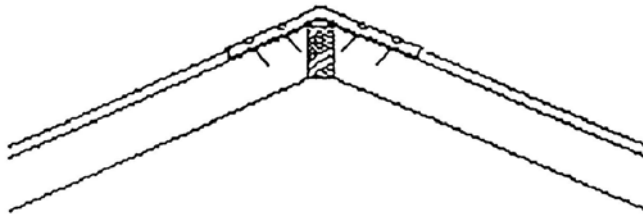

- (iii) METAL STRAPS over the top of the rafters.

## 9.3 Securing the corrugated galvanized sheets

The sheets are gauged by numbers. The Higher the number the thinner the material. Example 24 gauge galvanized sheet is superior to 28 gauge.

- (i) How does roof sheeting fail in cyclones?

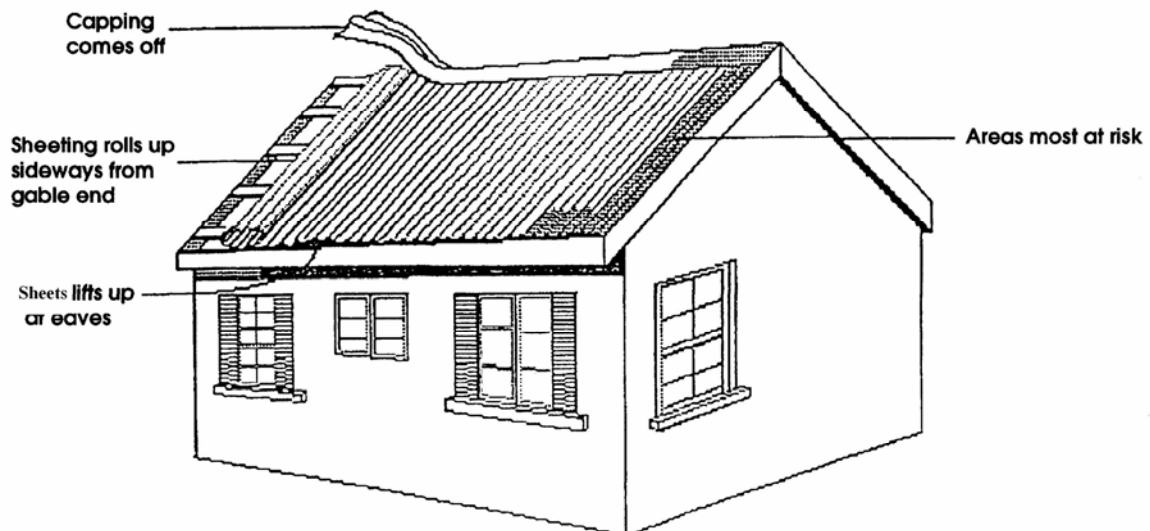

## (ii) Failure in roofs

If the sheeting is too thin or there are too few fittings, the nails or screws may tear through the sheet.

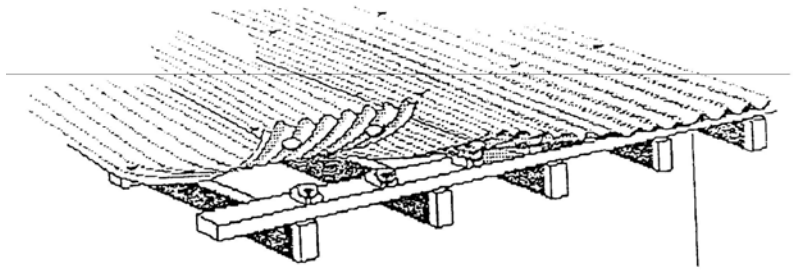

(iii) If galvanized sheets are used, 24 gauge is recommended.

(iv) How to secure sheeting to the roof structure, use

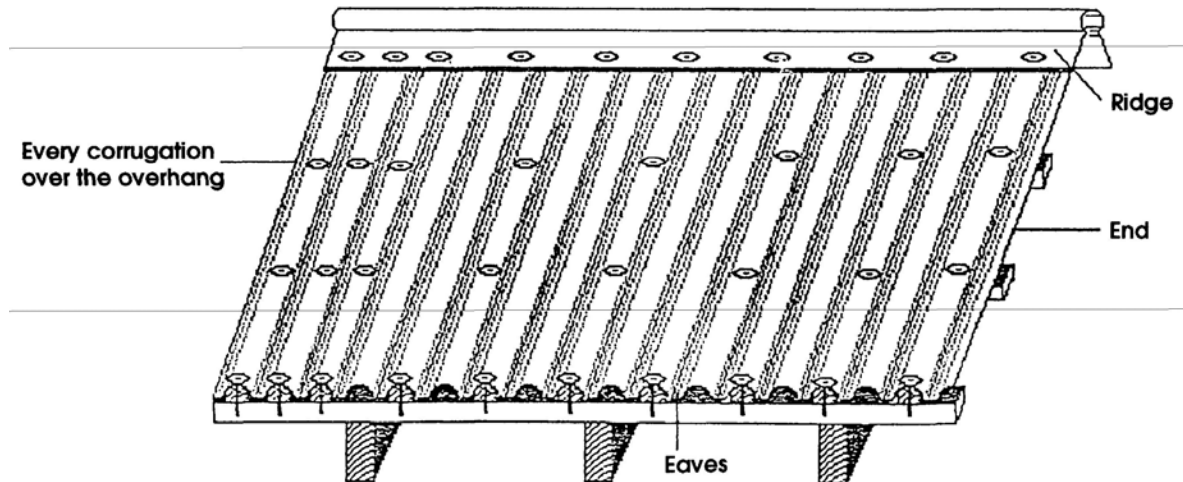

- Fixings every two (2) corrugation at ridges, eaves and overhangs.
- Fixings every three (3) corrugation. Maximum spacing at all other locations or use galvanised iron flats under the fixings.

## (v) Fixings for sheetings

Use fittings with a broad washer or dome head (zinc nail). To use more fixings for each sheet, put in the laths at closer centres and nail closer together.

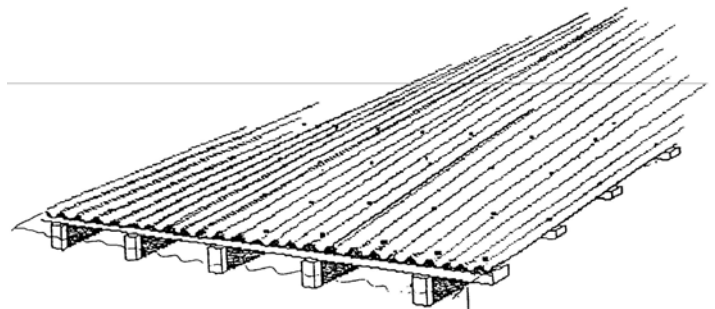

## Screws

- Use proper drive crews for corrugated galvanized roof sheets.
- Be sure that the screws go into the purlins at least fifty (50) mm.
- use large washers under the screw heads to prevent the roof sheets from tearing when pulled upward by high winds.

## Nails

- Nails do not hold as well as screws.

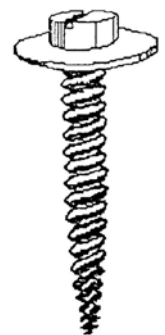

- Use nails with wide heads and long enough to bend over below the lath.
- Galvanized coated nails are better than ordinary wire nails.



#### 9.4 Laths spacing and fixing

- Spacing for laths and number of fixings will vary with the gauge of sheeting used.
- Screws hold better than nails so fewer screws can be used. But the sheeting must be thick or they will tear through.
- Laths should be placed closer together for thin sheets to provide space for extra fixings.
- A guide to the number of fixings and spacing of laths is shown below.

Gauge of Sheeting	Spacing of Laths
26	450 mm – 600 mm
25	600 mm – 750 mm
24	600 mm for nails, 900 mm for screws

#### 9.5 Hipped roof

This is the strongest type with all sides of the roof sloped. There are no gable ends in this roof. Instead, rafters come across diagonally from the corner and meet the ridge board a short distance from the ends of the house. These are the hip rafters. Other shorter rafters go from the wall plate to the hip rafter and are called jack rafters. After the ridge is firmly in position, the rafters are attached to fit neatly onto the wall plate.

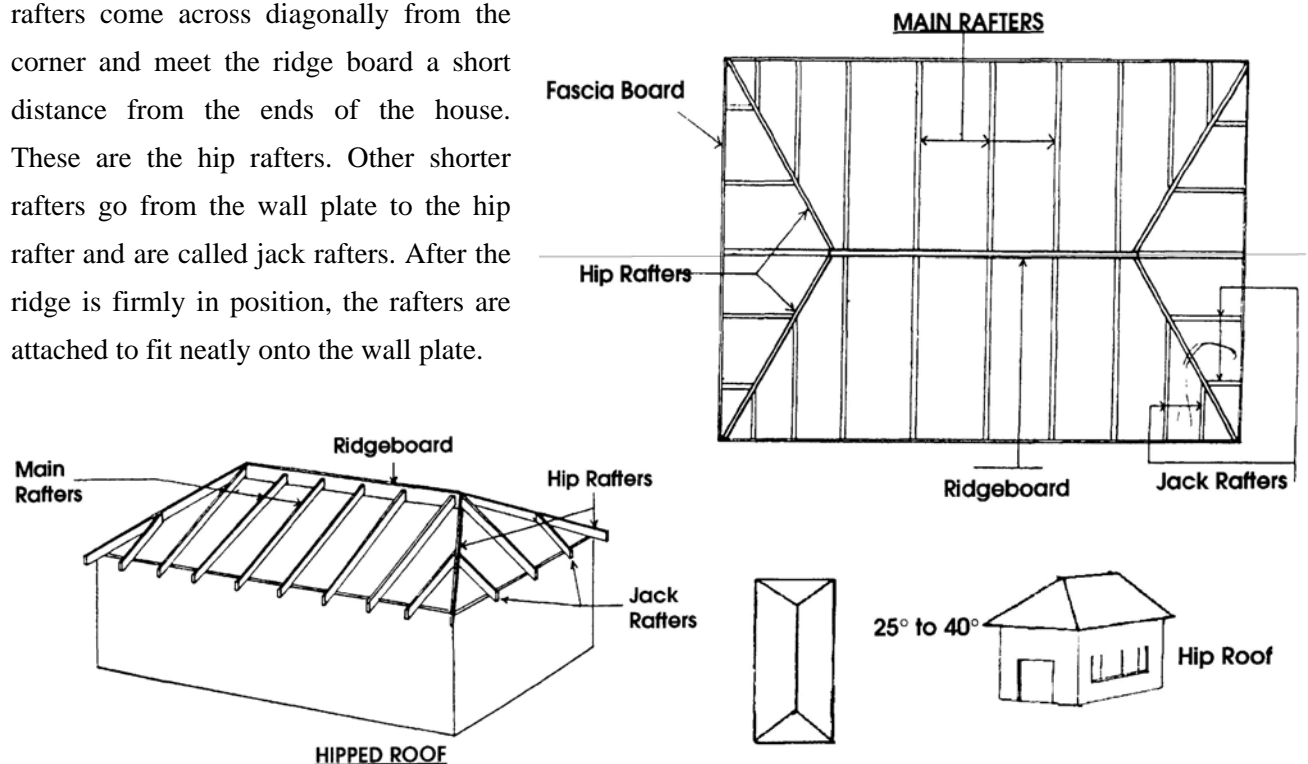

*Note:- Experience and experiment have shown that the hip roof with the pitch in 25° to 40° range has best record of wind resistance*

## 9.6 Roof cladding

As the corners and the roof edges are zones of higher local wind suctions and the connections of cladding/sheeting to the truss need to be designed for the increased forces. Failure at any one of these locations could lead progressively to complete roof failure. The following precautions are recommended:-

- (i) *Sheeted roofs*:- A reduced spacing of bolts,  $\frac{3}{4}$  of that admissible as per IS:800, recommended. For normal connections, J bolts may be used but for cyclone resistant connections U – bolts are recommended. Alternatively a

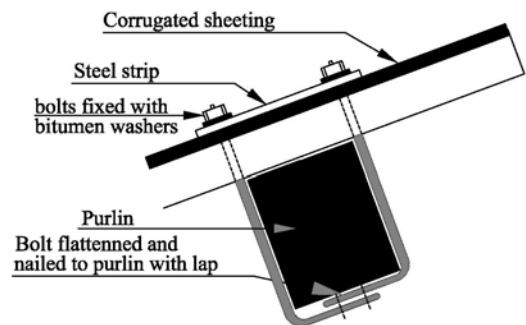
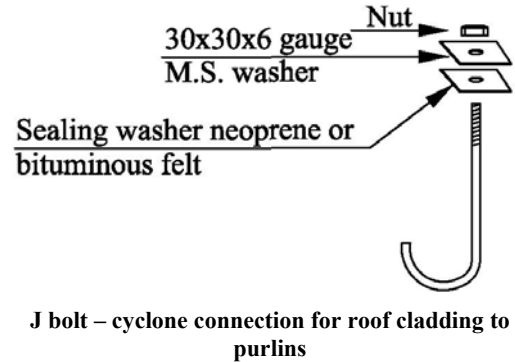
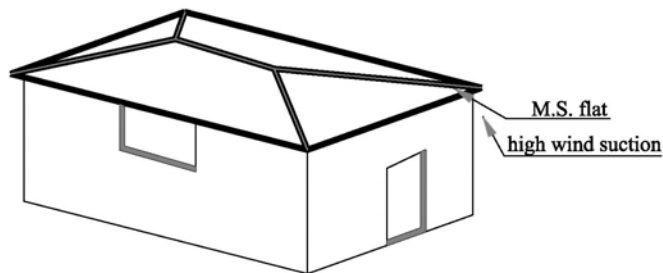
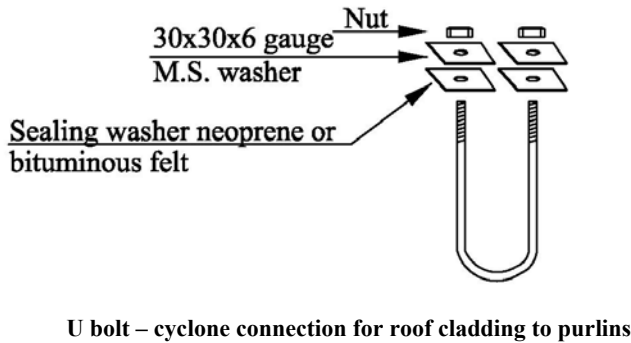

strap may be used at least along edges to fix cladding with the purlins to avoid punching through the sheet. Properly connected M.S. flat can be used as reinforcing band in high suction zones. The corrugated sheeting should be properly overlapped (at least 2 1/2 corrugation) to prevent water from blowing under the seam. Spaces between the sheeting and the wall plate should be closed up to prevent the wind from getting under the sheeting and lifting it. This can be done by nailing a fascia board to the wall plate and rafters.

- (ii) *Clay tile roofs*:- Because of lower dead weight, these may be unable to resist the uplifting force and thus experience heavy damage, particularly during cyclones. Anchoring of roof tiles in R.C. strap beams is recommended for improved cyclone resistance. As alternative to the bands, a cement mortar screed, reinforced with galvanized chicken mesh, may be laid over the high suction areas of the tiled roof.

*Note:- Covering the entire tile roof with concrete or ferro-cement will prevent natural breathing through the tiles and will make them thermally uncomfortable.*

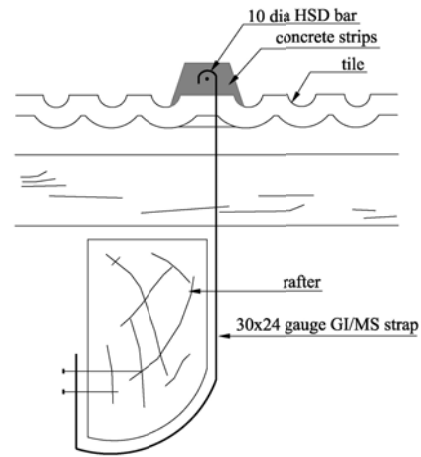
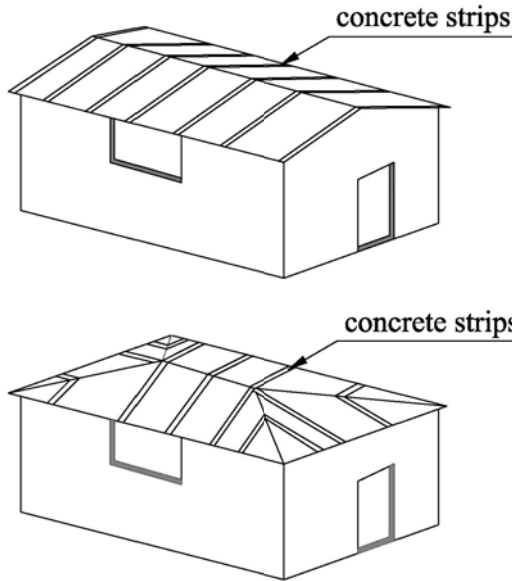

**Connection of concrete strips to rafter**

(iii) *Thatch roof*: - Thatched roof should be properly tied down to wooden framing underneath by using organic or nylon ropes in diagonal pattern. The spacing of rope should be kept 450 mm or less so as to hold down the thatch length. For connecting the wooden members, use of non corrodible fixtures should be made. If non-metallic elements are used, these may need frequent replacement. After a cyclone warning is received, all the lighter roofs should be held down by a rope net and properly anchored to ground.

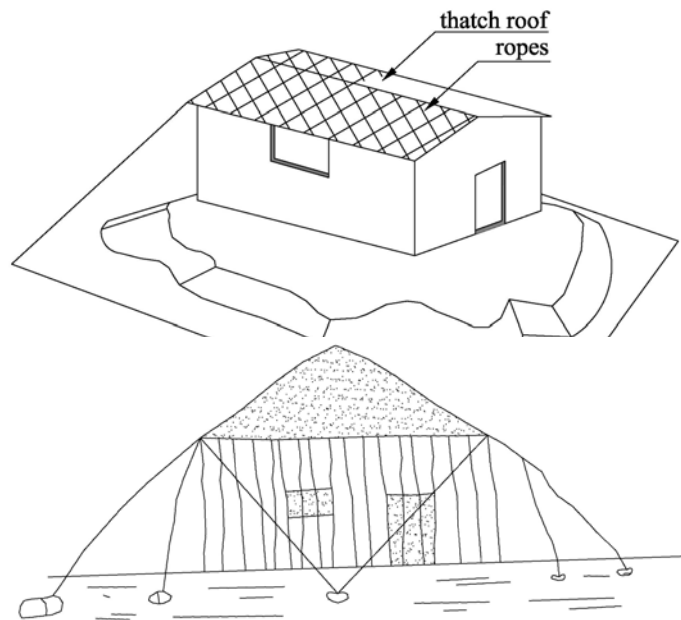

**Rope tie-backs for weak structures**

(iv) *Anchoring of roof framing to wall/posts*:- The connection of roof framing to the vertical load resisting elements i.e. wall or post, by providing properly designed anchor bolts and base plates is equally important for overall stability of the roof. The anchoring of roof framing to masonry wall should be accomplished through anchor belts embedded in concrete cores. The weight

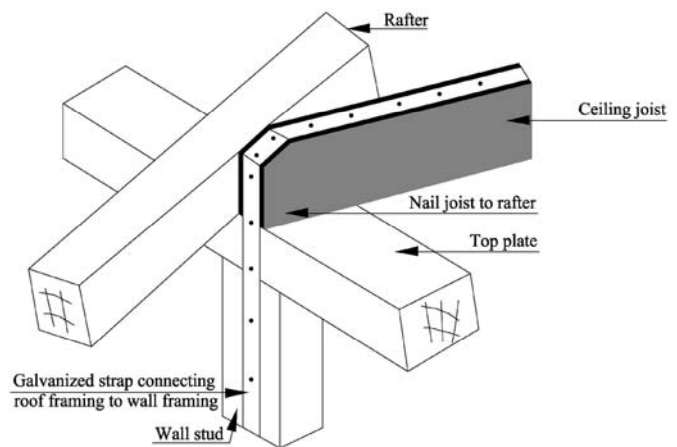

**Connection of roof framing to wall framing**

of participating masonry at an angle of half horizontal to 1 vertical should be more than the total

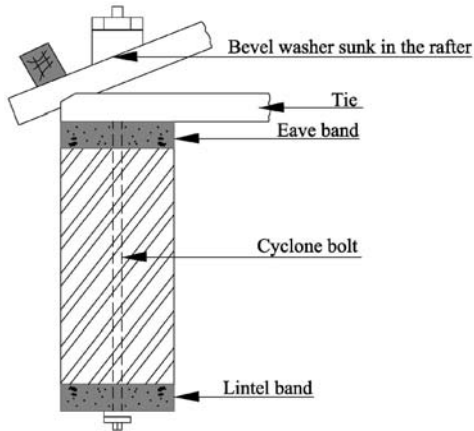

Connection of roof framing to wall

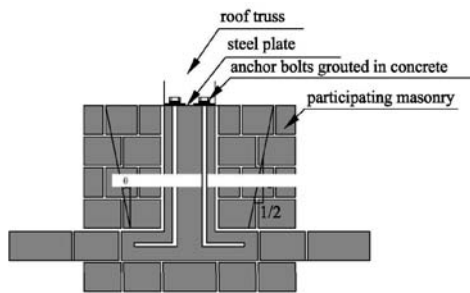

$$\theta = \tan^{-1}(1/2)$$

Anchoring of roof framing in masonry

uplift at the support. In case of large forces, the anchoring bars can be taken down to the foundation level with a structural layout that could ensure the participation of filler and cross walls in resisting the uplift.

(v) *Bracing*:- Adequate diagonal or knee bracing should be provided both at the rafter level and the eaves level in a pitched roof. The purlins should be properly anchored at the gable end. It is desirable that at least two bays, one at each end, be braced both in horizontal and vertical plane to provide adequate wind resistance. Where number of bays is more than 5, use additional bracing in every fourth bay.

(vi) *Flutter*:- In order to reduce wind induced flutter/vibration of the roof in cyclonic regions, it is recommended that all members of the truss and the

bracings be connected at the ends by at least two rivets/bolts or welds. Further the cross bracing members by welded/connected at the crossings to reduce vibrations.

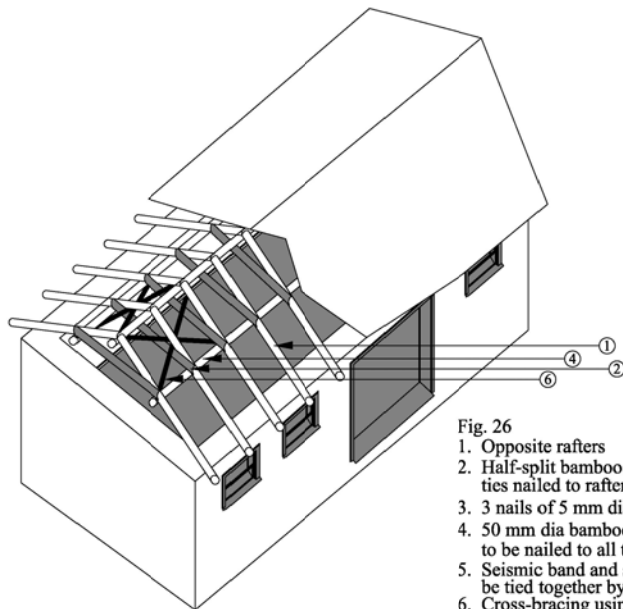

Fig. 26

1. Opposite rafters
2. Half-split bamboo or 50 x 50 mm wooden ties nailed to rafters
3. 3 nails of 5 mm dia at joints
4. 50 mm dia bamboo or 50 x 50 mm wooden ties to be nailed to all the rafters
5. Seismic band and sloping rafter to be tied together by wire
6. Cross-bracing using bamboos or 30 x 40 mm timbers to connect rafters at ends of each room

Note:

To avoid splitting of the ends of bamboos, drill a 4 mm dia hole in the bamboos before nailing

### Bracing the raftered roofs

## 10. Foundations

The foundation is the part of the house which transfers the weight of the building to the ground. It is essential to construct a suitable foundation for a house as the stability of a building depends primarily on its foundation. Buildings usually have shallow foundation on stiff sandy soil and deep foundations in liquefiable or expansive clayey soils. It is desirable that information about soil type be obtained and estimates of safe bearing capacity made from the available records of past constructions in the area or by proper soil investigation. In addition the following parameters need to be properly accounted in the design of foundation.

- (i) *Effect of surge or flooding:-* Invariably a cyclonic storm is accompanied by torrential rain and tidal surge (in coastal areas) resulting into flooding of the low lying areas. The tidal surge effect diminishes as it travels on shore, which can extend even upto 10 to 15 km. Flooding causes saturation of soil and thus significantly affects the safe bearing capacity of the soil. In flood prone areas, the safe bearing capacity should be taken as half of that for the dry ground. Also the likelihood of any scour due to receding tidal surge needs to be taken into account while deciding on the depth of foundation and the protection works around a raised ground used for locating cyclone shelters or other buildings.
- (ii) *Buildings on stilts:-* Where a building is constructed on stilts it is necessary that stilts are properly braced in both the principal directions. This will provide stability to the complete building under lateral loads. Knee bracings will be preferable to full diagonal bracing so as not to obstruct the passage of floating debris during storm surge.

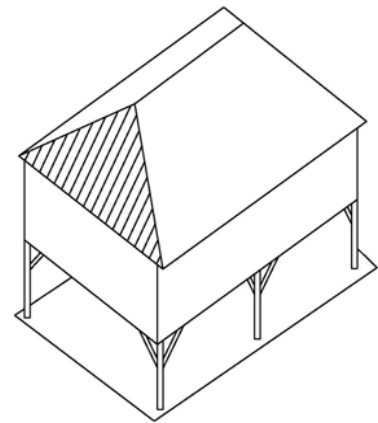

**Building on stilts**

**The main types of foundation are:**

### **Slab or Raft Foundation**

- Used on soft soils.
- Spread the weight over a wider area

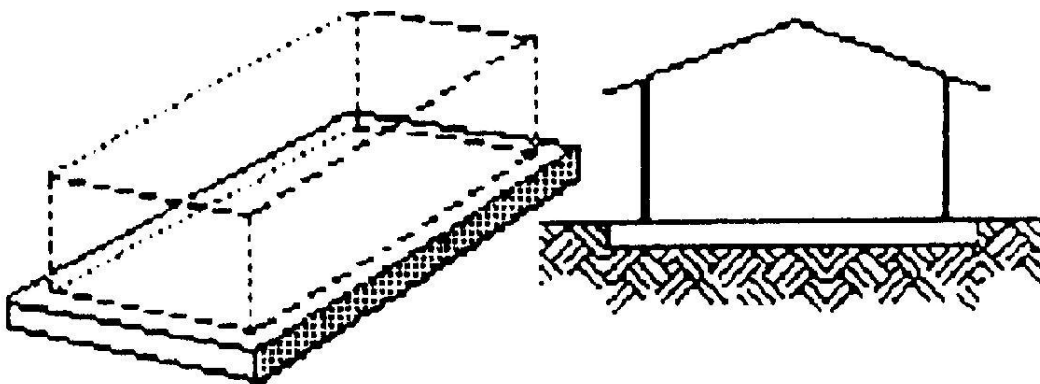



### Strip Foundation

- Used for areas where the soil varies.
- Most common.
- Supports a wall.

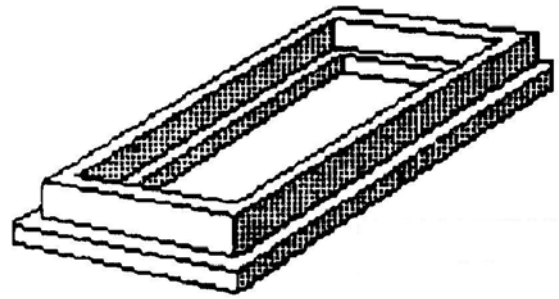
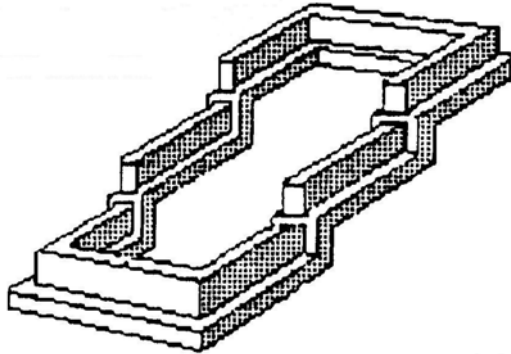

### Stepped Foundation

- Used on sloping ground.
- Is a form of strip foundation.

### Pile Foundation

- Are deep foundations for small or large buildings.
- Under reamed piles often used in expansive clay or alluvial soils.

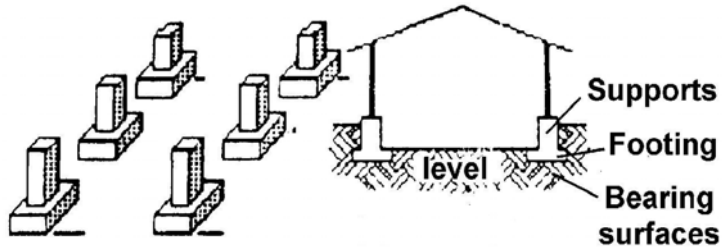
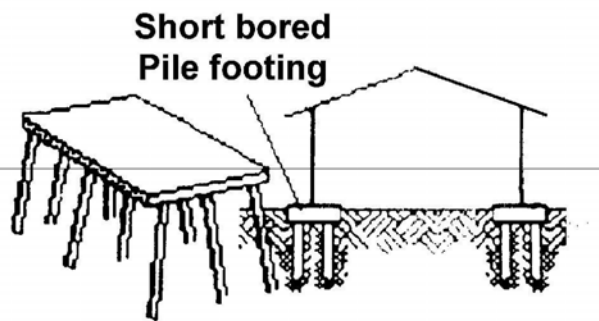

### Pad Foundation

- Used on firm soil.
- Used for columns & poles

## 11. Masonry walls

### 11.1 External walls

All external walls or wall panels must be designed to resist the out of plane wind pressure adequately. The lateral load due to wind is finally resisted either by walls lying parallel to the lateral force direction (by shear wall action) or by RC frames to which the panel walls must be fixed using appropriate reinforcement such as seismic bands at window lintel level.

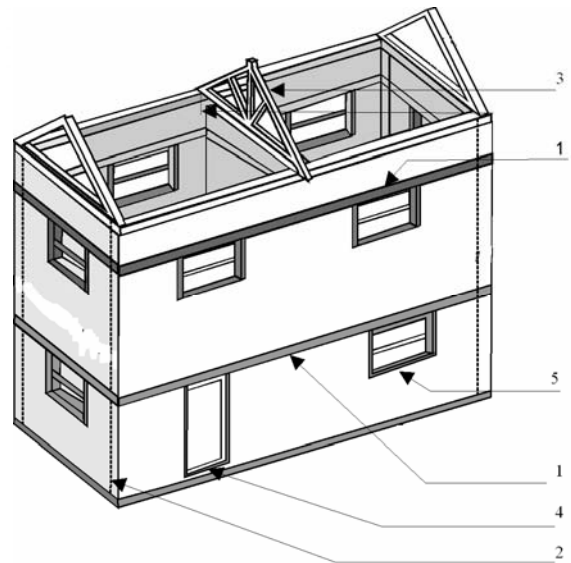
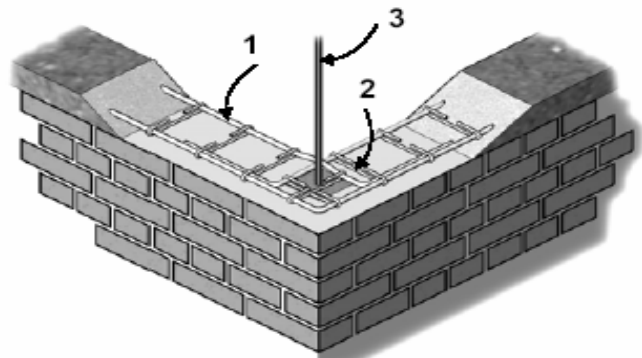

Fig. Showing the seismic band at lintel level and vertical reinforcement at corners

11.2 *Strengthening of walls against high wind/cyclones.*

For high winds in cyclone prone areas it is found necessary to reinforce the walls by means of reinforced concrete bands and vertical reinforcing bars as for earthquake resistance.



1. Longitudinal reinforcements
2. Lateral Ties
3. Vertical reinforcement at corners

View showing the connection between the vertical reinforcement and the seismic band at lintel level

**Recommended size and longitudinal steel in Seismic band in Cyclone Prone Areas (see fig.)**

Internal length of wall	Size of Band	For cyclone prone areas where wind speed is $\geq 47$ m/s	For cyclone prone areas where wind speed is $< 47$ m/s
		Reinforcement	Reinforcement
5 m or less	10 cm X wall width	2 bars of 10 mm dia.	2 bars of 8 mm dia.
6 m	10 cm X wall width	2 bars of 12 mm dia.	2 bars of 10 mm dia.
7 m	15 cm X wall width	4 bars of 10 mm dia.	4 bars of 8 mm dia.
8 m	15 cm X wall width	4 bars of 12 mm dia.	4 bars of 10 mm dia.

**Recommended size of vertical steel in Seismic band in Cyclone Prone Areas**

No. of storeys	Floor	For cyclone prone areas where wind speed is $\geq 47$ m/s	For cyclone prone areas where wind speed is $< 47$ m/s
		Reinforcement	Reinforcement
One	-	10 mm dia. bars	12 mm dia. bars
Two	Top	10 mm dia. bars	12 mm dia. bars
	Bottom	12 mm dia. bars	16 mm dia. bars
Three	Top	10 mm dia. bars	12 mm dia. bars
	Middle	12 mm dia. bars	16 mm dia. bars
	Bottom	12 mm dia. bars	16 mm dia. bars

\* Buildings of four storeys not desirable

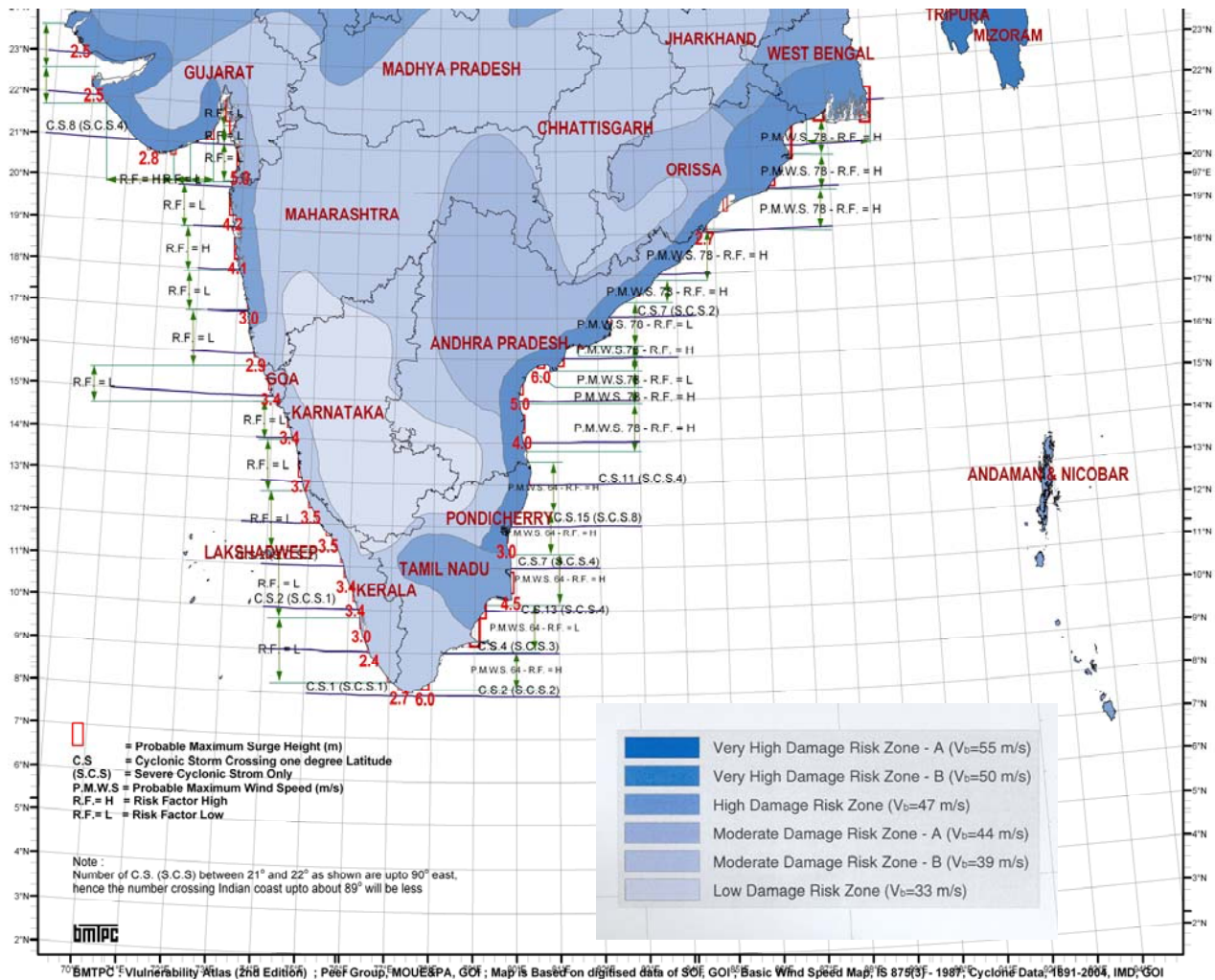
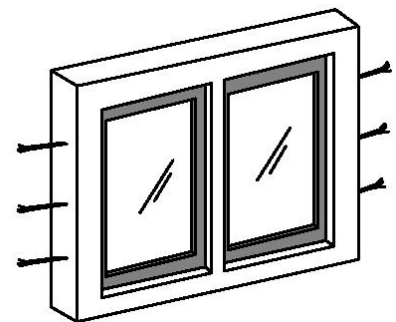

Fig. showing cyclone prone coastal areas

## 12. Wall Openings

Openings in general are areas of weakness and stress concentration, but needed essentially for light and ventilation. The following are recommended in respect of openings.

- (i) Openings in load bearing walls should not be within a distance of  $h/6$  from inner corner for the purpose of providing lateral support to cross walls, where 'h' is the storey height upto eave level.
- (ii) Openings just below roof level be avoided except that two small vents without shutter should be provided in opposite walls to prevent suffocation in case room gets filled with water and people may try to climb up on lofts or pegs.
- (iii) Since the failure of any door or window on the wind-ward side may lead to adverse uplift pressures under roof, the openings should have strong holdfasts as well as closing/locking arrangement.



Adequate anchorage of door and window frames with holders

### 13. Glass Panes

Apart from roofs, the elements requiring the most attention are windows and doors. Sadly, these are often neglected even when buildings are formally designed by professionals. Glass windows and doors are, of course, very vulnerable to flying objects and there are many of these in cyclones. The way to reduce this problem is to provide well designed thicker glass panes. Further, recourse may be taken to reduce the panel size to smaller dimensions. Also glass panes can be strengthened by pasting thin film or paper strips. This will help in holding the debris of glass panes from flying in case of breakage. It will also introduce some damping in the glass panels and reduce their vibrations.

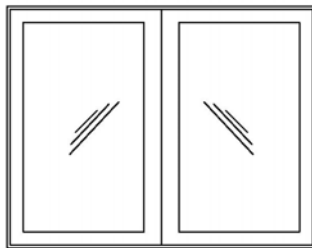

Large and thin unprotected glass areas in windows

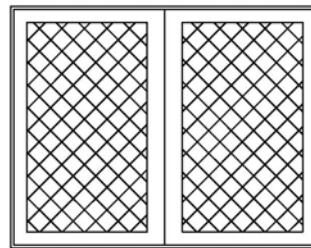

Glass protection by adhesive tapes

### 14. References

- 1) Guidelines for Cyclone Resistant Construction of Buildings in Gujarat, Gujarat State Disaster Management Authority, Government of Gujarat, December - 2001.
- 2) Make the Right Connections; A manual on safe construction techniques prepared as part of the OAS/USAID Caribbean Disaster Mitigation Project (CDMP).
- 3) Hurricanes and their Effects on Buildings & Structures in the Caribbean, Tony Gibbs, Director, CEP - This paper was presented at the USAID/OAS PGDM building inspector training workshop, held in Antigua in January 2001.
- 4) Natural Hazards: Causes and Effects, Lesson 5: Tropical Cyclones – University of Wisconsin Disaster management Centre.

**DESIGN PROCEDURE FOR WIND RESISTANT BUILDINGS**

The following procedure may be followed to design a building that will be resistant to damages during high winds/cyclones.

**A.1 Fix the Design Data**

- a. Identify the national wind zone in which the building is situated. This can be seen from wind code (IS: 875 Part 3-1987) or the Vulnerability Atlas of India (2006).
- b. Corresponding to the zone, fix the basic design wind speed,  $V_b$  which can be treated as constant upto the height of 10m.
- c. Choose the risk co-efficient or the importance factor  $k_1$ , for the building, as for example given below:

	<b>Building type</b>	<b>Coefficient <math>k_1</math></b>
i.	Ordinary residential building	1.0
ii.	Important building (e.g. hospital; police station; telecommunication, school, community and religious buildings, cyclone shelters, etc.	1.08

- d. Choose appropriate value of  $k_2$  corresponding to building height, type of terrain and size of building structure, as per IS: 875 (part 3), 1987. For buildings upto 10m height and category - A, which will cover the majority of housing, the values are:

	<b>Terrain</b>	<b>Coefficient <math>k_2</math></b>
i.	Flat sea-coastal area	1.05
ii.	Level open ground	1.00
iii.	Built-up suburban area	0.91
iv.	Built-up city area	0.80

- e. The factor  $k_3$ , depends upon the topography of the area and its location above sea level. It accounts for the acceleration of wind near crest of cliffs or along ridge lines and deceleration in valleys etc.

**A.2 Determine the wind forces**

- a. Determine the design wind velocity  $V_z$  and normal design pressure  $P_z$

$$V_z = V_b k_1 k_2 k_3$$

$$P_z = 0.0006 V_z^2 \cdot P_z \text{ will be in kN/m}^2 \text{ for } V_z \text{ in m/s}$$

- b. Corresponding to the building dimensions (length, height, width), the shape in plan and elevation, the roof type and its slopes as well as projections beyond the walls, determine the coefficients for loads on all walls, roofs and projections, taking into consideration the internal pressure based on size and location of openings. Hence calculate the wind loads on the various elements normal to their surface.

- c. Decide on the lines of resistance which will indicate the bracing requirements in the planes of roof slopes, at eave level in horizontal plane, and in the plane of walls. Then, determine the loads generated on the following connections:
- Roof cladding to Purlins
  - Purlins to rafters/trusses
  - Rafters/trusses to wall elements
  - Between long and cross walls
  - Walls to footings.

### ***A.3 Design the elements and their connections***

- a. Load effects shall be determined considering all critical combinations of dead load, live load and wind load. In the design of elements, stress reversal under wind suctions should be given due consideration. Members or flanges which are usually in tension under dead and live loads may be subjected to compression under dead load and wind, requiring consideration of buckling resistance in their design.
- b. Even thin reinforced concrete slabs, say 75mm thick, may be subjected to uplift under wind speeds of 55 m/s and larger, requiring holding down by anchors at the edges, and reinforcement on top face! As a guide, there should be extra dead load (like insulation, weathering course, etc) on such roofs to increase the effective weight to about 375 kg/m .
- d. Resistance to corrosion is a definite requirement in cyclone prone sea coastal areas. Painting of steel structures by corrosion-resistant paints must be adopted. In reinforced concrete construction, a mix of M20 grade with increased cover to the reinforcement has to be adopted. Low water cement ratio with densification by means of vibratos will minimise corrosion.
- e. All dynamically sensitive structures such as chimney stacks, specially shaped water tanks, transmission line towers, etc. should be designed following the dynamic design procedures given in various IS codes.
- f. The minimum dimensions of electrical poles and their foundations can be chosen to achieve their fundamental frequency above 1.25 Hz so as to avoid large amplitude vibrations, and consequent structural failure.

It may be emphasised that good quality of design and construction is the single factor ensuring safety as well as durability in the cyclone hazard prone areas. Hence all building materials and building techniques must follow the applicable Indian Standard Specifications.